

Molteni & C

MASTER DRESSING — VINCENT VAN DUYSSEN 2015

1—
16



Following the success of Gliss Master, Vincent Van Duysen has designed Master Dressing, a walk-in wardrobe system that completes the wide range of nighttime systems offered by Molteni&C. Master Dressing perfectly complements the Gliss Master wardrobes thanks to the use of coordinated internal fittings and aesthetic finishes, thereby providing functional and impactful walk-in closets. A distinctive structural feature is a new rack system to which wooden, lacquered, Fine Grain or glass back panels can be hooked. The system is fitted with newly designed shelf support rods that will take 30 mm thick Ecopelle and illuminated glass shelves, or 40 mm thick wooden shelves. Newly designed sets of drawers, new tie and foulard rack accessories. Brand new "Vanity" compartment, complete with large illuminated LED mirror.

DATASHEET

REGISTERED
DESIGN

IX.2022

FINISHES

| finishes | pewter colour / bronze | melamine | mat lacquer colours | woods | fine grain | coloured glass/ etched coloured glass | mirror | Eco Skin | transparent glass | grey saffiano melamine | piqué melamine |
|--|------------------------------|----------|---------------------------|-------|------------|---|--------|-----------|----------------------|------------------------------|-------------------|
| components | | | | | | | | | | | |
| back panel | | | | | | | | | | | |
| lateral finishing profile | | | | | | | | | | | |
| base with pewter colour/bronze edge | | | | | | | | | | | |
| filler strip | | | | | | | | | | | |
| shelf bracket | | | | | | | | | | | |
| wood shelf th 40 | | | | | | | | | | | |
| shelf th 30 with pewter colour/bronze profile | | | | | | | | | | | |
| clothes rails | | | | | | | | | | | |
| drawer front | | | | | | | | | | | |
| drawer front with pewter colour/bronze profile | | | | | | | | | | | |
| glass drawer front | profile | | | | | | | | | | |
| | glass | | | | | | | | | | |
| drawer unit structure | | | | | | | | | | | |
| drawer interior | | | | | | | | | | | |
| floor-standing drawer unit top | | | | | | | | | | | |
| shoe shelf | | | | | | | | only grey | | | |

| colours | Melamine | Matt lacquer | Woods | Coloured glass | Etched coloured glass | Eco Skin |
|---------|-------------------|--------------------|-----------------|--------------------|-----------------------|------------|
| | YM larix dark | BC chalk white | EU eucalyptus | BC chalk white | BC chalk white | grey |
| | YA silver cembran | PE pearl | RF graphite oak | PE pearl | PE pearl | mink |
| | WW white | DN dune | | DN dune | DN dune | hemp |
| | QC light chestnut | PL platinum | | PL platinum | PL platinum | ivory |
| | QS dark chestnut | NE black | | NE black | NE black | dark brown |
| | QA ivory tatami | AT anthracite | | AT anthracite | AT anthracite | earth |
| | QG grey tatami | SE mustard | | SE mustard | SE mustard | arctic |
| | | SI silica | | SI silica | SI silica | taupe |
| | | DO dolomite grey | | DO dolomite grey | DO dolomite grey | |
| | | AL clay | | AL clay | AL clay | |
| | | MK moka | | MK moka | MK moka | |
| | | CZ light blue grey | | CZ light blue grey | CZ light blue grey | |
| | | SA sand | | SA sand | SA sand | |
| | | RU ruby | | RU ruby | RU ruby | |
| | | PX pewter colour | | PX pewter colour | PX pewter colour | |
| | | RX copper | | RX copper | RX copper | |
| | | TO dove grey | | TO dove grey | TO dove grey | |
| | | PR petroleum blue | | PR petroleum blue | PR petroleum blue | |
| | | BG burgundy | | BG burgundy | BG burgundy | |
| | | LS london sky | | LS london sky | LS london sky | |
| | | SU stardust | | SU stardust | SU stardust | |
| | | ML moonlight | | ML moonlight | ML moonlight | |
| | | SP spice | | SP spice | SP spice | |

DATASHEET

REGISTERED
DESIGN

IX.2022

TECHNICAL INFORMATION

WALL PROFILE

Extruded anodised aluminium.

BACK PANEL, DRAWER UNIT AND TRAY FRONTS, DRAWER SIDES AND BOTTOM (MELAMINE FACED)

Wooden particleboard panel faced with melamine.

BACK PANEL, DRAWER UNIT STRUCTURE, DRAWER AND TRAY FRONTS (LACQUER)

Wooden particleboard panel faced with melamine, painted in the colours of the “Molteni Range”.

BACK PANEL (GLASS VERSIONS)

Wooden particleboard panel faced with melamine, with applied mirror or tempered glass (th. 5 mm), transparent or etched, painted in the colours of the “Molteni Range”.

FINE GRAIN BACK PANEL

Chipboard coated with cylinder etched coextruded sheet of ABS-PMMA, painted in specific Molteni finish.

MELAMINE FACED SHELF/BASE

Wooden particleboard panel faced with melamine. Base with adjustable feet and perimeter profile in extruded aluminium.

LACQUERED SHELF/BASE

Wooden particleboard panel faced with melamine, painted in the colours of the “Molteni Range”. Base with adjustable feet and perimeter profile in extruded aluminium.

WOOD SHELF/BASE

Wooden particleboard panel faced with wood veneer in Oak (Quercus) or Eucalyptus (Eucalyptus globulus). Base with adjustable feet and perimeter profile in extruded aluminium.

INNER SHELVES IN ECO SKIN

Chipboard panel covered with melamine facing, front profile in painted extruded aluminium and upper covering in eco-leather.

GLASS FRONT PANEL AND GLASS SHELVES

In painted or extruded aluminium. 4-mm-thick tempered glass.

FINE GRAIN FRONT

Chipboard panel covered with cylinder etched coextruded sheet of ABS-PMMA, painted in specific Molteni finish. Perimeter profile in painted extruded aluminium.

CLOTHES ROD / SIDE CLOSING PROFILE / TROUSERS HANGER BAR

In painted or extruded aluminium.

FIXING BRACKET / TIE RACK

Painted laser cut metal sheet.

ECOSKIN COVER

Folded metal sheet covered in eco-leather.

VANITY MIRROR

Painted extruded aluminium with etched silver coloured glass th. mm 4 with protective safety film.

LIGHTING AND ELECTRICAL COMPONENTS

All components are compliant with regulations and certified as shown on the individual parts.

DATASHEET

REGISTERED
DESIGN

IX.2022

MASTER
DRESSING—
VINCENT
VAN DUYSSEN
2015

TECHNICAL INFORMATION

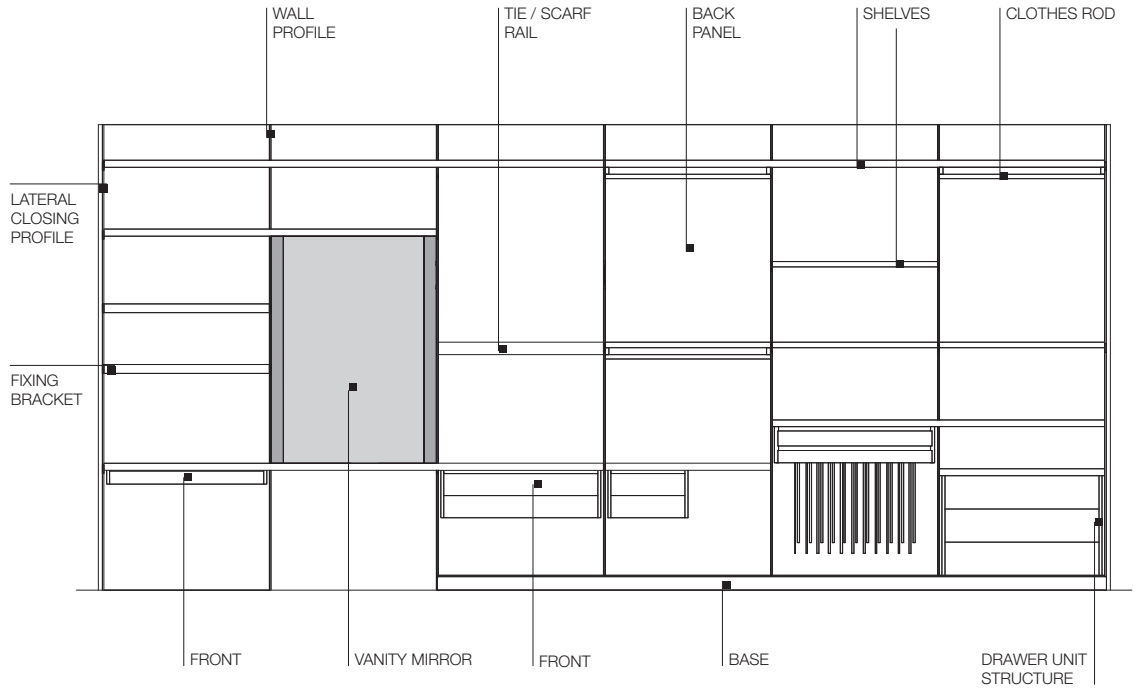

Molteni & C

4—
16

DATASHEET

REGISTERED
DESIGN

IX.2022

moltenigroup.com

Dimensions in millimeters and inches. The right to discontinue and make changes is reserved. This information is based on the latest product information available at the time of printing.

MODULARITY

Molteni & C

5—
16

For assembly, consider the minimum distance from the ceiling of 20 mm

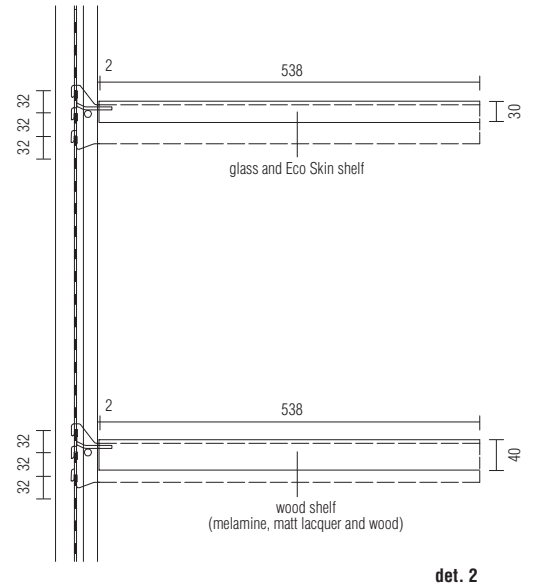
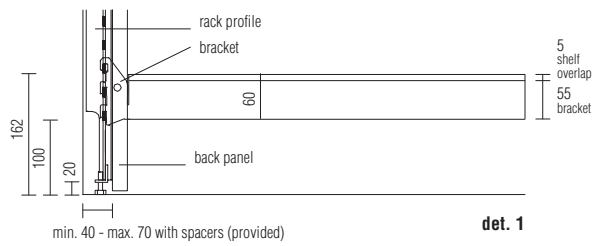
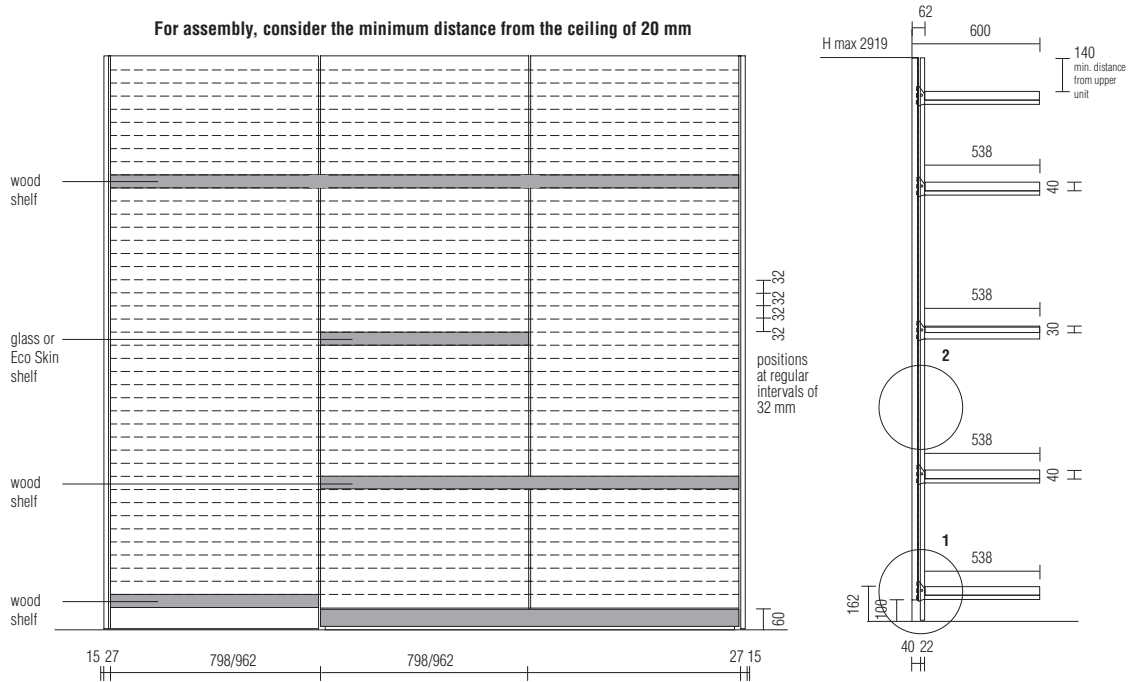

DATASHEET

REGISTERED
DESIGN

IX.2022

MODULARITY

Linear modules

Standard compositions are built in the same heights as Gliss Master (H 2919, 2631, 2439, 2343), and widths are decided based on the 798/962 mm module plus 42 mm at the beginning and end of the composition (if the composition is set between two walls).

Modules can be reduced in both height and width.

It is possible to reduce the depth of the following components up to a maximum of -160 mm (from 538 mm to 378 mm):

- bases
- wood shelves th 40
- glass and Eco Skin shelves th 30
- shelf fixing bracket

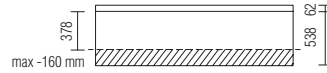

Molteni & C

6—
16

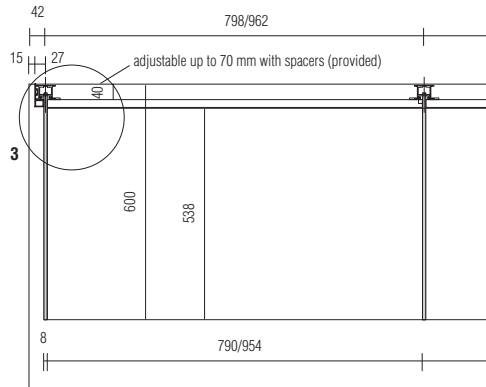

with adjustment of up to 55mm

Compensation strip
max width 270 mm

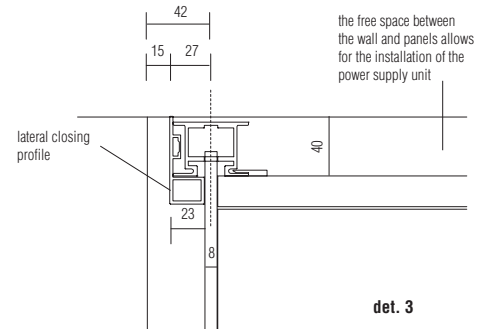

Single module

- Melamine shelf th 40
- Lacquered shelf th 40
- Wood shelf th 40
- Glass shelf th 30
- Eco Skin shelf with profile th 30

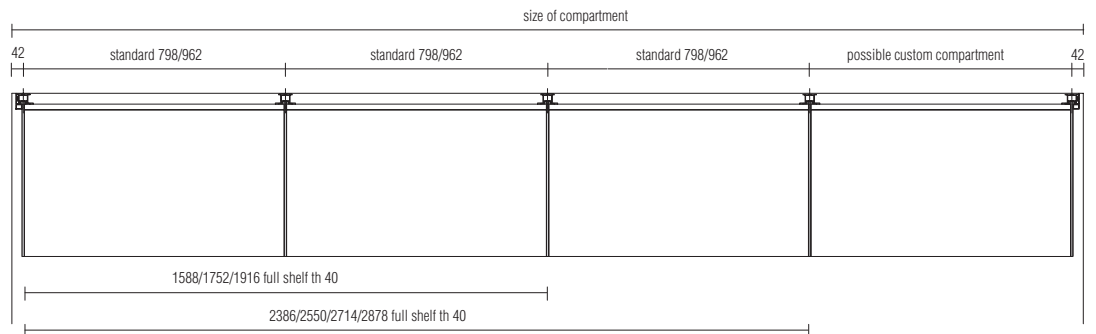

Shelves (th 40) in the finishes melamine, lacquer and wood are also available in full lengths for 2 or 3 modules.

All shelves can be reduced in width for custom compartments.

DATASHEET

REGISTERED
DESIGN

IX.2022

MODULARITY

Corner modules

With Master Dressing, it is possible to create L-shaped or C-shaped corner compositions. To design these compositions, in addition to the centre distance of the standard module (798/962 mm) and the starting distance (42 mm), it is necessary to consider the measurements of the corner (65 and 604 mm) as shown in the examples below.

Molteni & C

7—
16

L-shaped corner composition

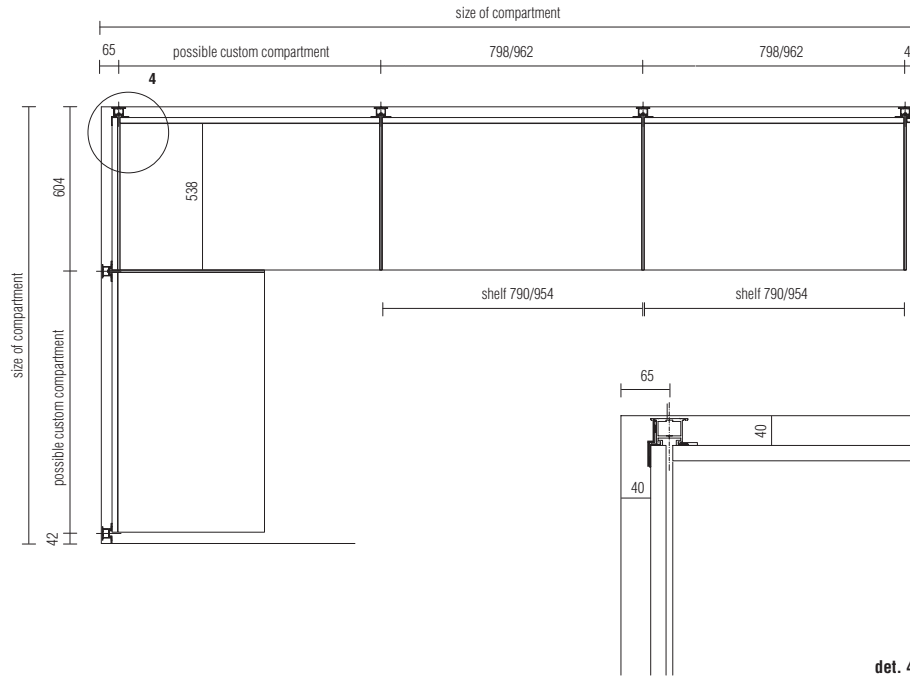

C-shaped corner composition

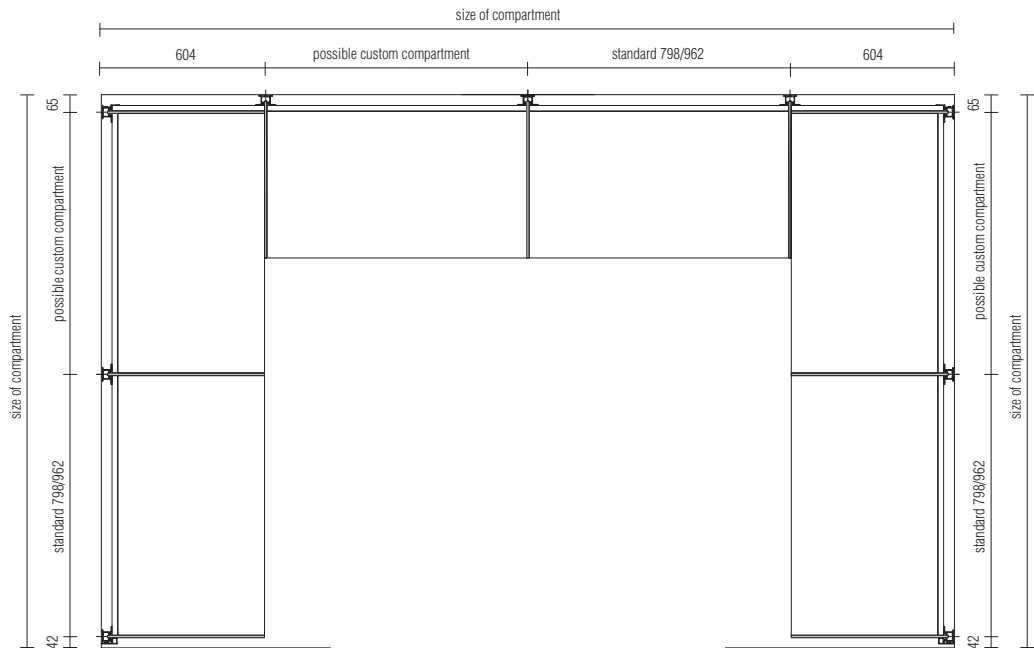

DATASHEET

REGISTERED
DESIGN

IX.2022

MODULARITY

Example 1

This example shows the different ways of using the fittings and the possibility of mounting structures on the wall.

Example 2

A simple illustration of how to determine the number of brackets required for the composition.

Example 1 - fittings

Shelves th 30 (glass and Eco Skin) are max. 1 module wide (954 mm).
Shelves th 40 (wood) are available in a width of max 3 modules (2878 mm).

Molteni & C

8—
16

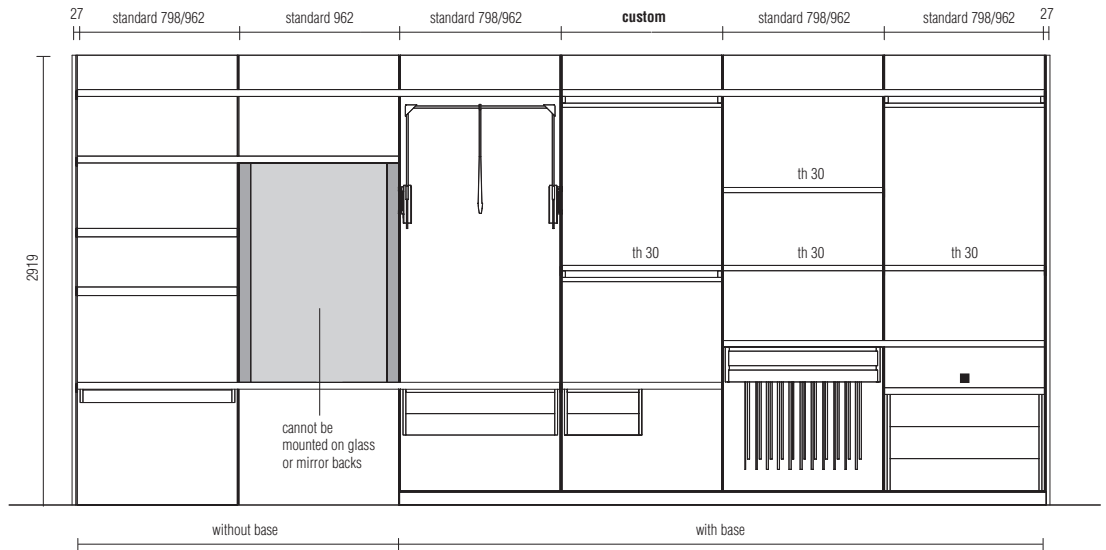

■ = the drawer unit set on the floor or on the base does not have fixing brackets and is not aligned with the intervals of the shelves

Example 2 - brackets

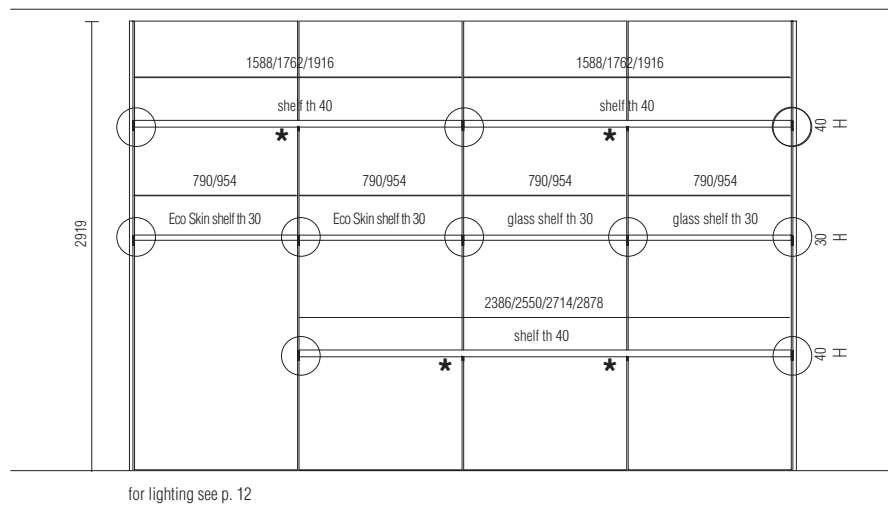

It is advisable to avoid placing shelves th 30 right next to shelves th 40, especially if they are supporting wall-mounted drawer units

○ = bracket to count

* = brackets included in the price of the shelf for 2 or 3 modules

DATASHEET

REGISTERED
DESIGN

IX.2022

COMPONENTS

Molteni & C

9—
16

Reducible
in height

Wall-mounted
profile



H 2343 H 2439 H 2631 H 2919
PMU23 PMU24 PMU26 PMU29

Wall-mounted
corner profile

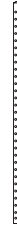

H 2343 H 2439 H 2631 H 2919
PMA23 PMA24 PMA26 PMA29

Lateral closing
profile



H 2343 H 2439 H 2631 H 2919
PLA23 PLA24 PLA26 PLA29

Reducible in
height
and width

Linear module back
W 790/954 th 20
W 31 1/8" / 37 1/2" th 3/4"

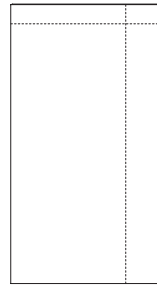

W 790 W 790 W 790 W 790
H 2343 H 2439 H 2631 H 2919
SHL8/23 SHL8/24 SHL8/26 SHL8/29

Reducible in
height
and width

Corner module back
W 560 th 20
W 22" th 3/4"



W 954 W 954 W 954 W 954
H 2343 H 2439 H 2631 H 2919
SHL9/23 SHL9/24 SHL9/26 SHL9/29

Lateral
filler strip
W 270 max.
W 10 5/8"



H 2343 H 2439 H 2631 H 2919
SHA5/23 SHA5/24 SHA5/26 SHA5/29
FL29

Bracket for fixing shelves
H 55 th 8
H 2 1/8" th 3/8"

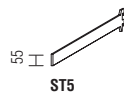

ST5

Supplement for electrical contact on bracket
(always on the left of the shelf with LED)
see example on p. 6

ESU1

DATASHEET

REGISTERED
DESIGN

IX.2022

COMPONENTS

Bases
th 60 D 538
th 2 3/8" D 21 1/8"
pewter colour or
bronze profile on
perimeter edge

reducible in width

W 798 - 31 3/8"
W 962 - 37 7/8"

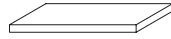

W 798 W 962
BA5/08 BA5/09

W 1596 - 62 7/8"
W 1760 - 69 1/4"
W 1924 - 75 3/4"

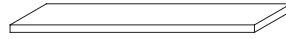

W 1596 W 1760 W 1924
BA5/16 BA5/17 BA5/19

W 2394 - 94 1/4"
W 2558 - 100 3/4"
W 2722 - 107 1/8"
W 2886 - 113 5/8"

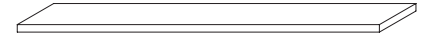

W 2394 W 2558 W 2722 W 2886
BA5/23 BA5/25 BA5/27 BA5/28

Molteni & C

10—
16

Wood shelves
th 40 D 538
th 1 5/8" D 21 1/8"
lateral brackets not
included in the price

reducible in width

W 790 - 31 1/8"
W 954 - 37 1/2"
(1 module)

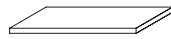

W 798 W 954
RI5/08 RI5/09

W 1588 - 62 1/2" (798+798)
W 1752 - 69" (962+798)
W 1916 - 75 3/8" (962+962)
(2 modules)
includes a
central bracket

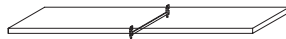

W 1588 W 1752 W 1916
RI5/16 RI5/17 RI5/19

W 2386 - 93 7/8" (790+790+790)
W 2550 - 100 3/8" (790+790+962)
W 2714 - 106 7/8" (790+962+962)
W 2878 - 113 1/4" (962+962+962)
(3 modules)
includes 2
central brackets

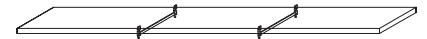

W 2386 W 2550 W 2714 W 2878
RI5/23 RI5/25 RI5/27 RI5/28

**Eco Skin and
transparent glass
shelves**
th 30 D 538
th 1 1/8" D 21 1/8"
lateral brackets not
included in the price

reducible in width

Eco Skin
W 790 - 31 1/8"
W 954 - 37 1/2"

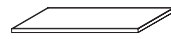

RE5/08 RE5/09

transparent glass
W 790 - 31 1/8"
W 954 - 37 1/2"



RV5/08 RV5/09

Shoe shelves
D 538 - 21 1/8"
lateral brackets not
included in the price

no reductions are
possibles

W 790 - 31 1/8"
W 954 - 37 1/2"

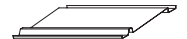

RP5/08 RP5/09

DATASHEET

REGISTERED
DESIGN

IX.2022

COMPONENTS

Clothes rail
W 790 - 31 1/8"
W 954 - 37 1/2"

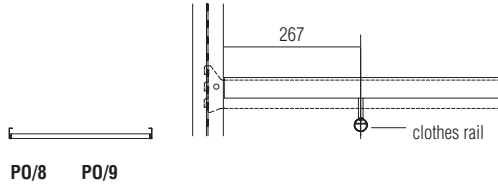

Hanger

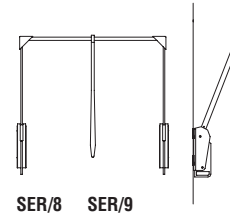

Tie or scarf rail
only for W 971 - 38 1/4"
pewter colour / bronze finish

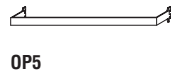

Pull-out coat hanger rail
only for wood shelves
brown finish

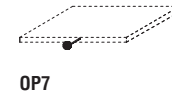

Vanity mirror
only for compartment W 954 - 37 1/2"
Backlit with dedicated switch.
The electrical system for the mirror is
independent of the rest of the closet.
The mirror is fastened to the back panel.

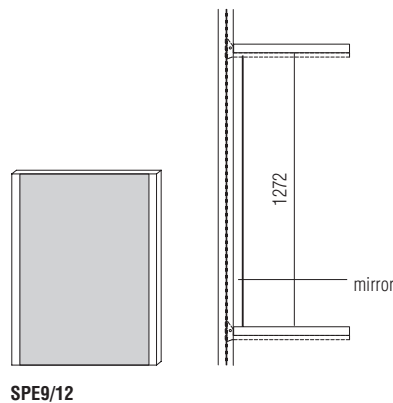

Eco Skin Cover
for wood shelves
W 790 - 31 1/8"
W 954 - 37 1/2"

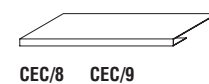

DATASHEET

REGISTERED
DESIGN

IX.2022

COMPONENTS

Drawer units

Wood shelves th 40 and Eco Skin shelves th 30 can receive the wall-mounted drawer unit structures. In this case, it is advisable to not place them side by side because the drawer units would not be aligned.

Floor-standing drawer units or on bases, cannot be aligned with closet shelves.

Structures can receive several drawers or trays in compliance with the modularity indicated with the dots •.

Drawers and trays are fitted with HOLD or CAVE handles.

For the CAVE handle covered in Eco Skin, add a supplementary charge each.

Wooden drawer finishes

melamine front in structure finish

fine grain finish front with pewter colour or bronze profile (**only HOLD handle**)

drawer inside in grey saffiano melamine

Glass drawer finishes (only HOLD handle)

transparent glass front with pewter colour or bronze frame

inside in grey saffiano melamine

Trouser holder finishes

melamine front in the same finish as the structure or fine grain with pewter colour or bronze profile

inner frame in grey saffiano melamine with trouser holder

in grey saffiano embossed.

Fine grain **only on HOLD handle**

Trinket tray finishes

melamine front in the same finish as the structure or fine grain with pewter colour or bronze profile

inner frame, bottom and grid in grey saffiano melamine.

Fine grain **only on HOLD handle**

Molteni & C

12—
16

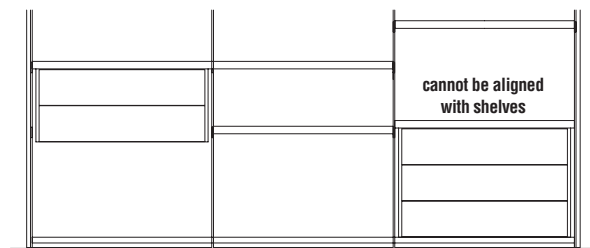

HOLD handle



CAVE handle

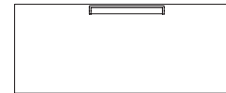

Floor-standing structures must always be closed with a finishing top in the finishes melamine, matt lacquer or wood (NO piqué).

No reductions of any kind are possible.

floor-standing structure/ on base

W 790/954 - 31 1/8" / 37 1/2"
H 390 - 15 3/8"

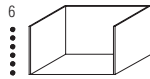

CST8/04 CST9/04

W 790/954 - 31 1/8" / 37 1/2"
H 582 - 22 7/8"

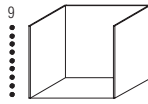

CST8/06 CST9/06

W 790/954 - 31 1/8" / 37 1/2"
H 774 - 30 1/2"

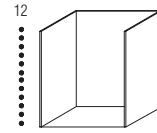

CST8/08 CST9/08

finishing top W 790/954 th 40

W 31 1/8" / 37 1/2" th 1 5/8"
Mandatory for each
floor-standing or base
supported drawer unit



TOQ8 TOQ9

suspended structures

W 790/954 - 31 1/8" / 37 1/2"
H 85 - 3 3/8"

for use only with
1 trinket tray
or 1 trouser holder

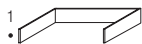

CSA8/01 CSA9/01

W 790/954 - 31 1/8" / 37 1/2"
H 166 - 6 1/2"

for use only with
2 trinket trays
or 1 trinket tray
and 1 trouser holder

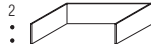

CSA8/02 CSA9/02

W 790/954 - 31 1/8" / 37 1/2"
H 262 - 10 3/8"

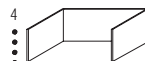

CSA8/03 CSA9/03

W 790/954 - 31 1/8" / 37 1/2"
H 390 - 15 3/8"

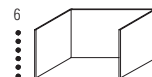

CSA8/04 CSA9/04

W 422 - 16 5/8"
H 390 - 15 3/8"

For custom compartments.
Can be positioned on
right or left always with
2 drawers CLN4/19

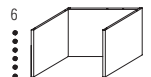

CSA4/04

DATASHEET

REGISTERED
DESIGN

IX.2022

COMPONENTS

Molteni & C

13 —
16

| | | | | |
|--------------------|---|--|-----------------------|--|
| HOLD handle | trinket trays (tie and belt) W 716/880 D 478 H 61 | trouser holders trays W 716/880 D 478 H 61 n. 9/12 bars | additional bar | wooden drawer W 416 D 478 H 190 usable space W 370 D 435 H 106 |
|--------------------|---|--|-----------------------|--|

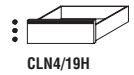
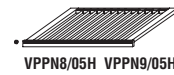
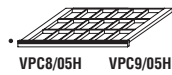

| | | | | |
|--------------------|--|--|--|---|
| HOLD handle | wooden drawers W 716/880 D 478 H 126 usable space W 670/834 D 435 H 77 | W 716/880 D 478 H 190 usable space W 670/834 D 435 H 106 | W 716/880 D 478 H 382 usable space W 670/834 D 435 H 298 | glass drawer W 716/880 D 478 H 190 usable space W 670/834 D 435 H 106 |
|--------------------|--|--|--|---|

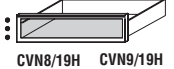
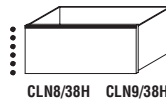
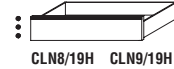
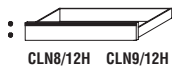

| | | | |
|--------------------|---|--|-----------------------|
| CAVE handle | trinket trays (tie and belt) W 716/880 D 478 H 61 | trouser holders trays W 716/880 D 478 H 61 n. 9/12 bars | additional bar |
|--------------------|---|--|-----------------------|

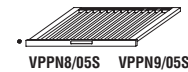
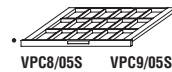

| | | | | |
|--------------------------|--|---|--|--|
| upper CAVE handle | wooden drawer W 416 D 478 H 190 usable space W 370 D 435 H 106 | W 716/880 D 478 H 126 usable space W 670/834 D 435 H 77 | W 716/880 D 478 H 190 usable space W 670/834 D 435 H 106 | W 716/880 D 478 H 382 usable space W 670/834 D 435 H 298 |
|--------------------------|--|---|--|--|

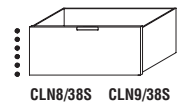
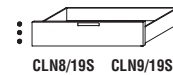
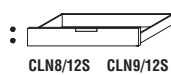
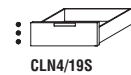

| | | | | |
|--------------------------|--|---|--|--|
| lower CAVE handle | wooden drawer W 416 D 478 H 190 usable space W 370 D 435 H 106 | W 716/880 D 478 H 126 usable space W 670/834 D 435 H 77 | W 716/880 D 478 H 190 usable space W 670/834 D 435 H 106 | W 716/880 D 478 H 382 usable space W 670/834 D 435 H 298 |
|--------------------------|--|---|--|--|

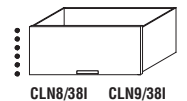
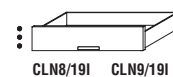
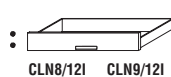

DATASHEET

REGISTERED
DESIGN

IX.2022

LIGHTING

LED Lighting

Shelves in wood, Eco Skin and glass can be outfitted with LED lighting. The wiring system is compliant with European safety standards. To allow the closet to be lit simply and quickly, the fixing profiles are wired with an electrified wire strip (see example on p.12) and the brackets are fitted with contacts.

Notes

When placing the order, the client must indicate on the drawing which shelf or shelves are to be fitted with the lighting bars. Bars are always aligned with shelf width.

Molteni & C

15—
16

electrified wire strip



up to H 2631 from 2632 to 2919
ECA2 **ECA3**

Supplement for electrical contact on bracket (always on left of shelf)

ESU1

lighting bars for shelves 3000 K



W 6
EBI9C

for shelves up to W 954



W 11,5
EBI19C

for shelves up to W 1916



W 17,5
EBI28C

for shelves up to W 2878

**components
per system**
(see the diagram for
component use and to
calculate system cost)

power supply unit 100W

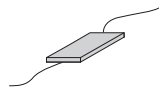

EAL1

connector



EC01

**radio control kit
with brightness
setting
(1 per power
supply unit)
optional**



EKRR1

**DALI kit
(for DOMOTICA)**
n. 1 for each
power supply unit
cannot be used with
radio remote control

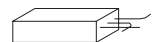

EKDA1

System for remote control switch or remote control device

- Wire strips and brackets: consider quantities as shown in the example on the previous page
- Power supply unit: each power supply unit can power max 100W
- Connector: n. 1 per 4 power supply units
- Radio remote control system (optional): with n.1 remote control device, it is possible to command n. 2 power supply units. If more are desired, then more remote control devices are required.

DATASHEET

REGISTERED
DESIGN

IX.2022

INTERNAL FITTINGS - ACCESSORIES FOR DRAWERS

Leather trays
Handmade leather trays with Alcantara bottom.
The version for men is brown (cat. P col. D533),
The version for women is powder pink (cat. P col. D524).

Eco Skin bottoms
Made with grey coloured Eco Skin.

leather trays
men's drawers
W 206 D 430 H 58 (A)
W 206 D 215 H 58 (B)

Molteni & C

16 —
16

watch holder
(A)

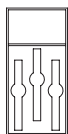

CEV/MA1

watch/
bracelet holder
(A)

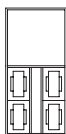

CEV/MA2

jewellery holder
with movable
dividers
(B)



CEV/MB1

complete men's
drawer offer



CVM1

leather trays
women's drawers
W 206 D 430 H 58 (A)
W 206 D 215 H 58 (B)

watch holder
(A)

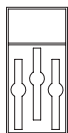

CEV/WA1

watch/
bracelet holder
(A)

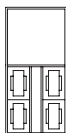

CEV/WA2

jewellery holder
with movable
dividers
(B)



CEV/WB1

ring holder
(B)



CEV/WB2

earring holder
(B)



CEV/WB3

complete women's
drawer offer

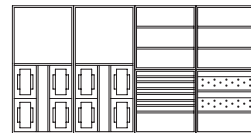

CVW1

Modularity drawings
for inserting trays into
drawers

drawer W 416

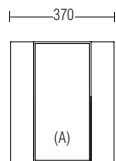

1 tray (A)
or 2 trays (B)

drawer W 716

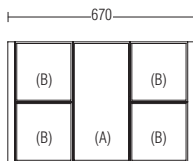

3 trays (A)
or 6 trays (B)

drawer W 880

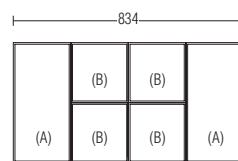

4 trays (A)
or 8 trays (B)

Eco Skin bottoms
for drawers
D 432



W 366
CEQ/F4

W 666
CEQ/F8

W 830
CEQ/F9

DATASHEET

REGISTERED
DESIGN

IX.2022

moltenigroup.com

Dimensions in millimeters and inches. The right to discontinue and make changes is reserved. This information is based on the latest product information available at the time of printing.